

## *Precision Feeders*

High accuracy feeding solutions for industrial processes



**Volumetric Feeders  
for bulk materials**

# Feeding – At the centre of total process control



*Controlled feed into a Gericke continuous mixer*

**Proven designs with thousands of running applications.**

**G**ericke volumetric feeders are designed for throughputs from 0.05 to 50,000 litres per hour for most dry solids and liquid applications.

Gericke's range of feeders are based upon a robust modular design which are used in almost all processing applications including:

- **Chemical**
- **Foods**
- **Pharmaceutical**
- **Construction Minerals**
- **Plastics**
- **Detergents**

## **Gericke – Feeding of bulk material since 1894.**

**G**ericke offer cost effective feeding solutions for most powders, granules, fibres, flavours, pigments and liquids.

### **Added Benefit:**

Expert advice on correct selection and operation of the unit, prompt after sales support by specialist engineers, secure return on investment.



*GLD 87 VR;  
Compact feeder suitable  
for a wide range of material  
characteristics*

# Modular feeding equipment – designed for process flexibility

## Volumetric feeding



The feed rate is measured by volume against time.

A reliable volumetric device is essential for a high accuracy gravimetric weigh feeder.

Accurate metering of bulk solids is achieved using a spiral helix, rotary valve, rotating agitator, vibrating tray or cylindrical stator. Even in the volumetric mode, the metering rate remains constant under the condition of a repeatable fill level within of the selected feeding tool and an even bulk density of the powder.

## Gravimetric Feeding



The feedrate or batch weight is regulated by the process controller.



Batch feeding



Continuous feeding



Combination feeding

Using a gravimetric feeder with load cells, a batch weight can be accurately dispensed or the feed rate continuously controlled. The mode is dependent on the process requirements.

Gericke can upgrade most volumetric feeding models into Gravimetric devices.

# The right feeder for each specific application

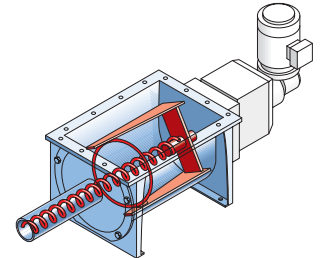
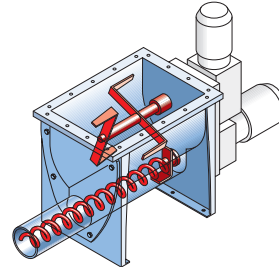
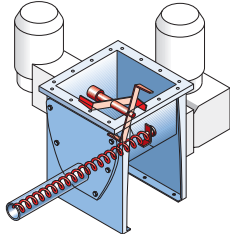
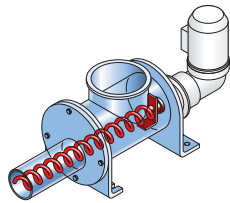

## GPD

### Low cost, efficient feeder

#### Application:

Free flowing dry materials for lower feed rates

#### Advantages:

Quick and simple to dismantle for wet and dry cleaning, light weight unit (9 Kg)

#### Capacity range\*:

0,05–600 l/h

#### Type:

GPD 100

## GLD

### Compact feeder with agitator for high accuracy feeding

#### Application:

Suitable for most dry solids, pilot plants, frequent product changes

#### Advantages:

Versatile, adaptable, compact, reliable, precise

#### Capacity range\*:

0,05–600 l/h

#### Type:

GLD 77 (mechanical agitator),  
GLD 87 (agitator with independent drive)

## GDU

### Universal feeder, minimal product retention, used for poor flowing materials

#### Application:

Medium to high capacity feed rates, hygienic design, difficult products, high feeding accuracy, raisin and fruit feeders, (special applications)

#### Advantages:

Versatile, adaptable, complete emptying

#### Capacity range\*:

1,3–25.600 l/h  
(depending on model)

#### Type:

GDU 201, GDU 451, GDU 801  
(with agitator),  
GDU 301, GDU 601  
(without agitator)

## GAC

### Universal Feeder for highest accuracy, homogeneity and distribution of bulk materials

#### Application:

Medium to high feed rates, very difficult materials, highest feeding accuracy batch weighing & feeding station (GAC 233F)

#### Advantages:

Feeding tool and homogeniser are concentrically aligned with large product entry suitable for difficult products

#### Capacity range\*:

1,3–27.000 l/h

#### Type:

GAC 207, GAC 232;  
GAC 233 F (with separate helix for coarse and trickle feeding)



GPD 100



GLD 87



GDU 451



GAC 207

\*Approximate throughput values based on Semolina. Minimum value using smallest helix diameter at 5% of speed range and maximum value with largest helix at 100%

Technical advantages of Gericke feeders:

- Robust construction
- High reliability for long life cycle
- Hygienic design (in accordance with EHEDG)
- Large range of feed tool lengths
- No segregation
- Large entry section
- Constant bulk density
- Crevice free surfaces
- Continuous welding (option)
- Range of drive options
- +/- pressure rated options available

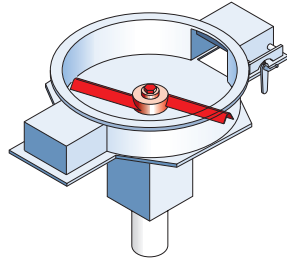
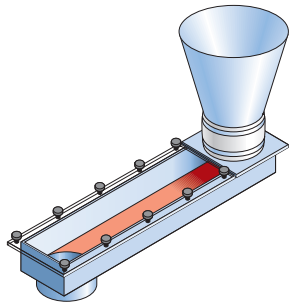

## VIBRO

Vibro feeder for coarse and fragile products

Application:  
Large capacity range, fragile or abrasive products, light and coarse materials, fibres

Advantages:  
No rotating parts, gentle operation, easy cleaning, no component wear

Capacity range\*:  
1-10000 l/h

## RA

Discharge and feeding device for very poor flowing products. A rotating paddle sweeps the product towards the outlet valves. An adjustable valve regulates the feed rate

Application:  
Discharge from silo's or hoppers, refilling loss-in-weight feeders, component feeding

Advantages:  
Discharge without segregation, feed-distribution (1 - 4 outlets) and shut off valve combined into one device

Capacity range\*:  
0,2-40.000 l/h

Type:  
RA 500, RA 800, RA 1200, RAS (RAS Type for over/under pressures)



The benefits:

- Easy cleaning
- High feeding accuracy
- Guaranteed recipe reliability
- Versatile applications
- Low maintenance costs
- Simple to control
- Adaptable (easily adaptable)



Vibro feeder



RA with 1 - 4 outlets

ISO 9001:2000

ISO 9001-2000 quality guarantee  
Gericke is a member of EHEDG

# Selecting the correct feeding tool

## Product Characteristics



- free flowing (*salt, corn, sugar*)
- flushing (*carbonates, fly ash, gypsum*)
- fluidisable (*cocoa*)
- cohesive (*TiO<sub>2</sub>, stearates*)
- adhesive (*carbon black, pigments*)
- abrasive (*quartz sand, silicon carbide*)
- compressible (*chalk*)
- fragile (*flakes, instant coffee*)

## Installation

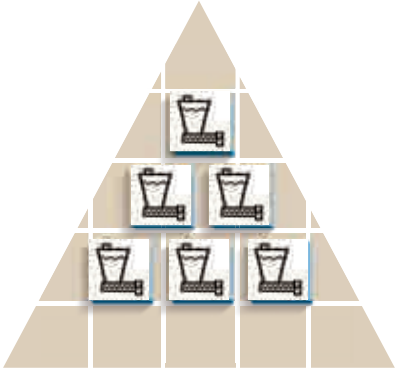

- Mounting (supported or hinged)
- Number of feeders
- Headroom
- Feed distance

## Process



- Capacity
- Operation mode (batch/continuous)
- Pressure rating
- Accuracy
- Level of automation

## Feeding tool selection

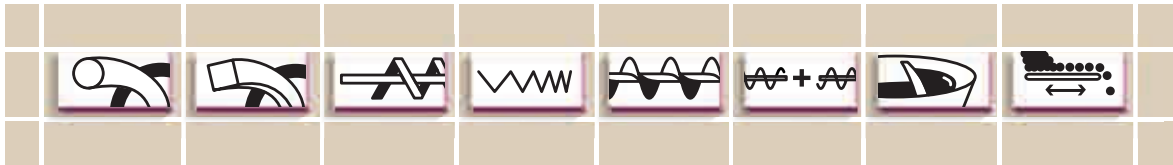

- Round spiral
- Square helix
- Helix with centre shaft and end bearing
- Variable pitch
- Full flight screw
- Vibro feeder
- Extended feed tool
- Fluidisation
- Rotating bin discharger

<b>Accessories for high feed accuracy</b>	<b>Agitator</b>	→ consistent product flow
	<b>Homogeniser</b>	→ repeatable bulk density for optimum feed accuracy
	<b>Bridge breakers</b>	→ Ensure difficult products discharge for the surge hopper into the feed chamber

# Ancillary process equipment

**Gericke feeders are designed using a modular system customised to the specific requirements of the application. The flexibility of the Gericke equipment range offers simplified system design and greater added value.**

- Special designs for agitators and homogenisers
- Surface finish and coatings; EGPDFE, Bead blast, electro-polished
- Variable feed tool lengths
- Shaft seals: stuffing box, PTFE lip seals, air purge glands
- AR outlet for vertical discharge
- ARFE outlet, flanged with end bearing
- ARFG outlet with "Granuflow" flow control
- AGP shut off valve with position indicator
- Hinged bottom door with safety switch
- FDA approved seals

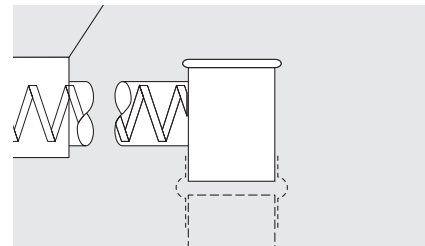

Type AR vertical outlet connection

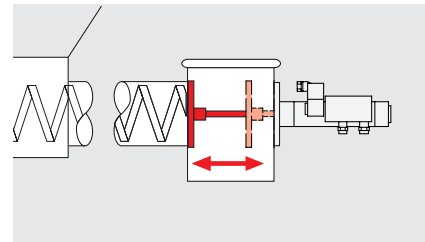

AGP outlet for instant product shut off (optional position indicator)



Semi-automated feeding station for accurate dosing into various sacks and boxes

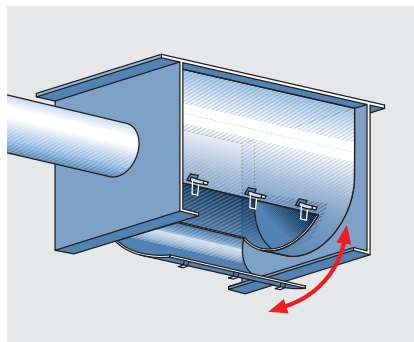

GAC feeder with hinged door for quick cleaning

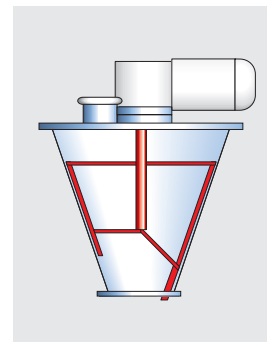

Hopper with vertical agitator

- Drive options
- Variable speed integrated frequency inverter
- Pressure tight design
- High temperature applications
- ATEX zones: 1, 2, 22, 21
- Special feeders for raisins and fruits.
- Pneumatic conveying feeder refill systems



GDU 601 with extended feed screw

## Selection of reference products

### Density kg/l

#### A

Activated Charcoal	0.21	Manganese Ore	1.8
Acrylic Resin (Fibres)	0.14	Marble Chips	1.5
Acrylic Resins (Granulated)	0.51	Marble Dust	1.2
Additives	0.2-0.4	Metallic Powder	3.04
Adipic Acid	0.62	Mica Flakes	0.16
Aerosil	0.046	Milk Powder	0.58
Aluminium Chloride	0.59	Molybdenum Oxide	1.82
Aluminium Flakes	1.30		
Aluminium Fluoride	1.22	<b>N</b>	
Aluminium Oxide	0.90	Nuts	0.41
Aluminium Powder	1.30	Nylon (Fibres)	0.16
Aluminium Silicate	0.54	Nylon (Flakes)	0.52
Aluminium Sulphate	0.90	Nylon (Granules)	0.57
Ammonium Nitrate	0.62	Nylon (Powder)	0.63
Ammonium Phosphate	0.83	<b>O</b>	
Antimony Oxide	0.69	Oat Cream Powder	0.57
Apple Pectin	0.51	Oat Flakes	0.45
Ascorbic Acid	0.55	Oat Flour	0.39

#### B

Barium Carbonate	0.17-1.4	Oat Flour (Chopped)	0.24
Barium Stearate	0.23	Onion(Powder)	0.41
Barium Sulphate	1.45	Ores	1.4-2.6
Barley Flour	0.63	Oxalic Acid	0.85
Bauxite	1.2	<b>P</b>	
Borax	0.97	Peppercorn	0.27
Brick Dust	1.2	Perlite (Expanded)	0.12
		Perlite (Rock)	1.17
		Perlon Wool	0.25

#### C

Cab-O-Sil	0.03	Pesticide	0.4-0.6
Calcium Carbonate	1.2	Phenol Resin (Powder)	0.54
Calcium Chloride	0.97-1.1	Pigments	0.2-1.0
Calcium Stearate	0.39	Polyethylene (Granules)	0.57
Calcium Sulphate	0.74	Polyethylene (Powder)	0.67
Carbon Black	0.4	Poly-Electrolyte	0.5-0.7
Casting Powder	0.69	Polyester Chips	0.15
Celite	0.25	Polyester Resin (Flakes)	0.4
Cellulose Acetate	0.13	Polypropylene (Granules)	0.5
Cement	1.2	Polypropylene (Powder)	0.54
Ceramic Mixture	1.4	Polystyrene (Expanded)	0.1
Charcoal Powder	0.40	Polystyrene (Granules)	0.6
Chicory Powder	0.49	Polystyrene (Powder)	0.65
Chocolate Powder	0.65	Polyvinyl Chloride (Granules)	0.62
Cinnamon Sugar	0.74	Potash (Flakes)	0.5
Citric Acid	0.8	Potassium Permanganate	1.1
Coal Dust	0.59	Potassium Sulphate	2.25
Cocoa Beans	0.56	Potato Flour	0.7
Cocoa Powder	0.5	PTFE (Granules)	0.53
Coffee Beans	0.39	PTFE Powder (Algoflow)	0.51
Coffee Powder	0.18	PVC Floor Covering Chips	0.6
Corn	0.6	PVC Powder	1.0
Cornflour	0.74	<b>Q</b>	
Corn Starch	0.48	Quartz Powder	1.2
		Quartz Sand	1.5

#### D

Dacron	0.51	<b>R</b>	
Dextrose	0.57	Rice	0.94
Detergents	0.3	Rice Crispiers	0.11
Diatomite	0.08-0.25	Rubber (Chips)	0.4
Dyestuffs	0.25-0.75	Rubber (Granules)	0.46

#### E

Egg Powder	0.35	<b>S</b>	
Electrode Carbon	1.0	Salt	1.18
Epoxy Resin Powder	0.8	Sand	1.6

#### F

Feedstuffs (Animal)	0.49	Sawdust	0.29-0.45
Ferric Chloride	1.6	Silica - Gel	0.25
Ferric Oxide	0.87-1.3	Silica	1.05
Felspar	1.2-1.8	Silica Acid (Powder)	0.23
Ferrisil	0.98	Sipernat	0.22
Fibres-Glass Fibres	0.2	Slag	0.4
Filtration Aids	0.23	Slag Wool	0.09
Filter Cakes	0.65	Soap Flakes	0.47
Fish Food	0.77	Soap Powder	0.58
Flavourings	0.33	Soda	1.0
Flue Ash	1.06	Sodium Bicarbonate	0.98
Flue Dust	1.30	Sodium Chloride	1.18
Foam Plastic Flakes	0.011	Sodium Nitrate	1.35
Foam Rubber	0.05	Sodium Perborate	0.78
Foam Shavings	0.25	Sodium Tripolyphosphate	0.78
Fungicide	0.41	Spice Mixture	0.75
Fullers Earth	0.35-0.6	Spinach Powder (Dry)	0.42
		Stabilisers	0.4
		Starch Granules	0.75
		Starch Powder	0.67
		Stearic Acid	0.55
		Styropor Pellets	0.58
		Sucrose	0.54
		Sucrose (Crystalline)	0.81
		Sugar (Crystalline)	1.02
		Sugar (Powder)	0.62
		Sugar (Raw)	0.81
		Synthetic Wax Powder	0.42
		Synthetic Resin Granules	0.55-0.65
		Synthetic Resin Powder	0.65-0.75

#### G

Garlic Powder	0.33	<b>T</b>	
Gelatine	0.74	Talcum	0.46
Glass (Ground)	1.7	Tea	0.39
Glass (Splinters)	1.65	Teflon Fibres	0.49
Glass (Fibres)	0.2	Terephthalic Acid	0.49
Glass (Frit)	1.95	Textile Fibres	0.14
Glass (Beads)	0.4	Titanium Dioxide (White)	0.79
Glazing Mixture	0.62	Tobacco (Cigarettes)	0.19
Glue Powder	0.6	Tobacco (Leaf)	0.1
Graphite (Granules)	1.12	Tri-Calcium Phosphate	0.49
Graphite (Powder)	0.58	Tri-Sodium Phosphate	0.75
Graphite (Salt)	0.5	Triphosphate	0.55
Grass Seed	0.16	Tungsten Carbide	3.28
Grinding Powder	2.3	<b>V</b>	
Gypsum	0.9	Varnish Powder (Course)	0.98
Gypsum Calcined	1.2	Vinyl Resin (Granules)	0.6
Gravel	1.4-1.7	Vinyl Resin Powder	0.57
		Vitamins	0.45-1.0

#### H

Herbicide	0.4-0.6	<b>W</b>	
-----------	---------	----------	--

#### I

Insecticide	0.4-0.6	Washing Powder	0.3
Iron Powder	3.5	Wheat Flour	0.64
Iron Sulphate	1.3	Wood Shavings	0.17

#### K

Kaolin (dry)	0.8	<b>Z</b>	
--------------	-----	----------	--

#### L

Lime (Quick)	0.9	Zinc Granules	4.0
Lime (Slaked)	0.62	Zinc Oxide	0.98
Limestone (Crushed)	1.35	Zinc Stearate	0.22
Limestone (Flour)	1.25		
<b>M</b>			
Magnesium Carbonate	0.25		
Magnesium Oxide	0.62		
Magnesium Stearate	0.34		
Malt Flour	0.63		
MalTED Milk	0.53		
Manganese Dioxide	1.08		

# World-wide Service Support

## Material reference chart:

The stated values are for indicative purposes only and are subject to confirmation after receipt of all application details. Planning drawings are available in dxf format from the Gericke web-site [www.gericke.net](http://www.gericke.net).

Type	Feed capacity range l/h*	Drive kW	Weight kg	Height, Width, Length (including drive and feed device) mm	Specials
<b>GPD 100</b>	0,05 – 600	0,12	9	270, 150, 480	without agitator
<b>GLD 77</b>	0,05 – 600	0,12	12	350, 200, 540	mechanical agitator
<b>GLD 87</b>	0,05 – 600	0,12	18	350, 350, 540	with independent drive
<b>GAC 207</b>	1,3 – 4.800	0,55	75	500, 290, 1110	homogenising
<b>GAC 232</b>	1,3 – 27.000	0,55	90	540, 390, 1260	homogenising
<b>GAC 233 F</b>	batch operation	0,55	140	450, 400, 1400	2 feedworms
<b>GDU 201</b>	1,3 – 800	0,55	50	340, 420, 1000	minimal product retention
<b>GDU 301</b>	1,3 – 11.200	0,55	40	280, 290, 1100	without agitator
<b>GDU 451</b>	10 – 11.200	0,55	100	680, 390, 1200	minimal product retention
<b>GDU 601</b>	10 – 25.000	0,55	50	360, 390, 1400	sack tipping
<b>GDU 801</b>	500 – 50.000	3,0	450	910, 1150, 2000	difficult powder
<b>Vibro</b>	0,5 – 10.000				
<b>KAD150</b>	batch operation	0,37	40	900, 510 diameter	conditioning
<b>RA 500</b>	400 – 40.000	3,0	100	ca. 600 diameter	1-4 outlets
<b>RA 800</b>	400 – 80.000	5,5	150	ca. 900 diameter	1-4 outlets
<b>RA1200</b>	400 – 100.000	200	200	ca. 1300 diameter	1-4 outlets

\*Approximate throughput values based on Semolina. Minimum value using smallest helix diameter at 5% of speed range and maximum value with largest helix at 100%



Feeding and sifting station for Pharmaceutical powders

Gericke feeders are used in a vast variety of production applications including: ice tea, syrups, spices, mustard, milk powder, cereal bars, pizza toppings, gypsum boards, salt, ceramics, metal coatings, PVC powder and many more.

# Gericke

## Powder Processing Equipment and Systems

**GB-Ashton** u. Lyne OL6 7DJ  
Tel. +44 (0)161 344 1140  
Fax +44 (0)161 308 3403  
[gericke.gb@gericke.net](mailto:gericke.gb@gericke.net)

**CH-8105 Regensdorf**  
Tél. +41 (0)44 871 36 36  
Fax +41 (0)44 871 36 00  
[gericke.ch@gericke.net](mailto:gericke.ch@gericke.net)

**Singapore 787813**  
Tel. +65 (0)64 52 81 33  
Fax. +65 (0)64 52 03 92  
[gericke.sg@gericke.net](mailto:gericke.sg@gericke.net)

**F-95100 Argenteuil**  
[gericke.fr@gericke.net](mailto:gericke.fr@gericke.net)

**NL-3870 Hoevelaken**  
[gericke.nl@gericke.net](mailto:gericke.nl@gericke.net)

**D-78239 Rielasingen**  
[gericke.de@gericke.net](mailto:gericke.de@gericke.net)

For further information about gravimetric feeders and controllers please request the Gericke leaflets No 624 **Easydos** and No 625 **Gravimetric feeders**.

We will be pleased to forward copies or alternatively they can be downloaded for our website [www.gericke.net](http://www.gericke.net)

<http://www.gericke.net>

[info@gericke.net](mailto:info@gericke.net)